

PPC2-C19-ADL

IEI Heavy Industrial Panel PC

Powered by Intel® Alder Lake S platform



IEI

WWW.IEIWORLD.COM

PPC2-C19-ADL

Panel PC equips 12th Gen Intel® Alder Lake S series processor, HDMI 2.0 display output, dual 2.5G Ethernet port, one PCIe Gen4 x16 slot, one M.2 M key & one M.2 E key expansion slots, anti-glare & anti-UV 10-point touchscreen, and IP65 compliant front panel



12th Gen Intel® Desktop Platform

Support 12th Gen Intel® Core™/Pentium® series desktop processor, and asynchronous architecture to unleash superb performance

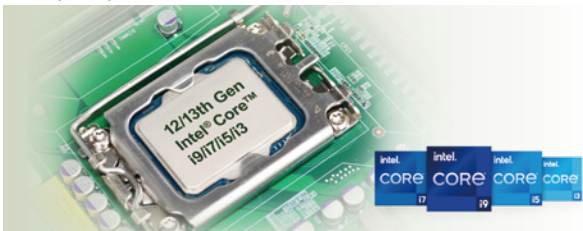

PCIe Gen4 x16 (x16 signal) Slot

One PCIe x16 for functional expansions like graphics cards, LAN cards or motion control cards.

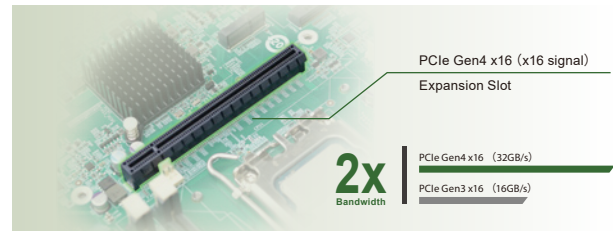

Anti-glare and Anti-UV PCAP

With anti-glare and anti-UV coating, the 10-point touchscreen can display clearly without reflection for a long time use in outdoors and bright light environment.

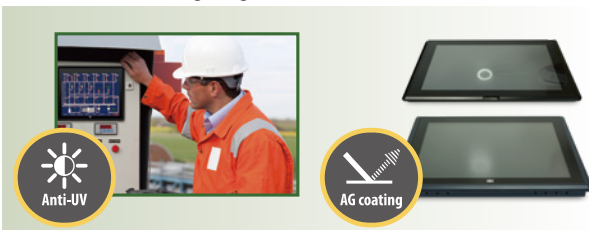

Support Gloved and Wet Hand Operation

The whole new PCAP screen allows you to accurately manage every step of your operations even with gloves or in wet conditions.



Newly Designed Panel Mount Kit

The new refined and convenient panel mount kit can be easily fastened by hand, no screwdriver required.

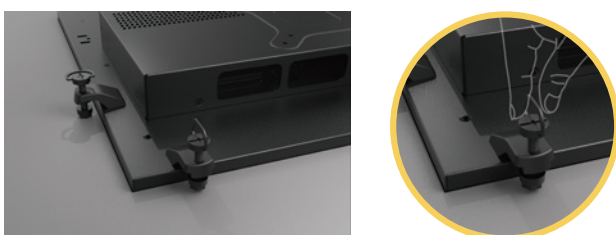

New Graphical BIOS Interface

Upgraded with new BIOS interface, which can be navigated with fingers, no keyboard and mouse are required to operate.

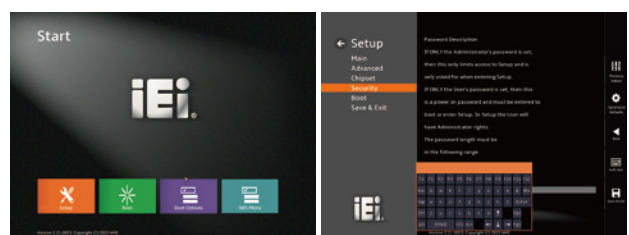

PPC2-C19-ADL I/O

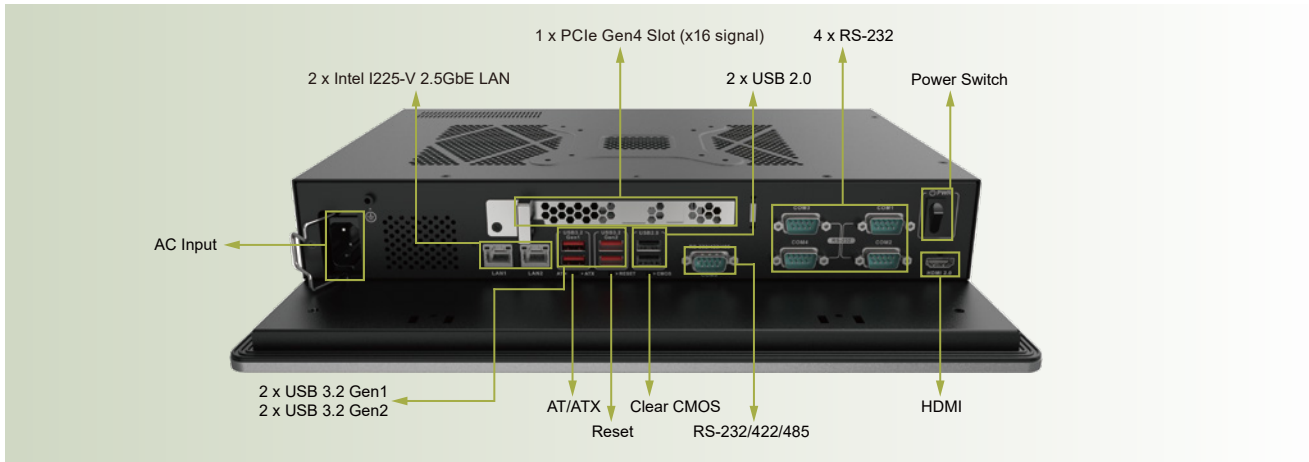

PPC2-C19-ADL Block Diagram

PPC2-C19-ADL Block Diagram

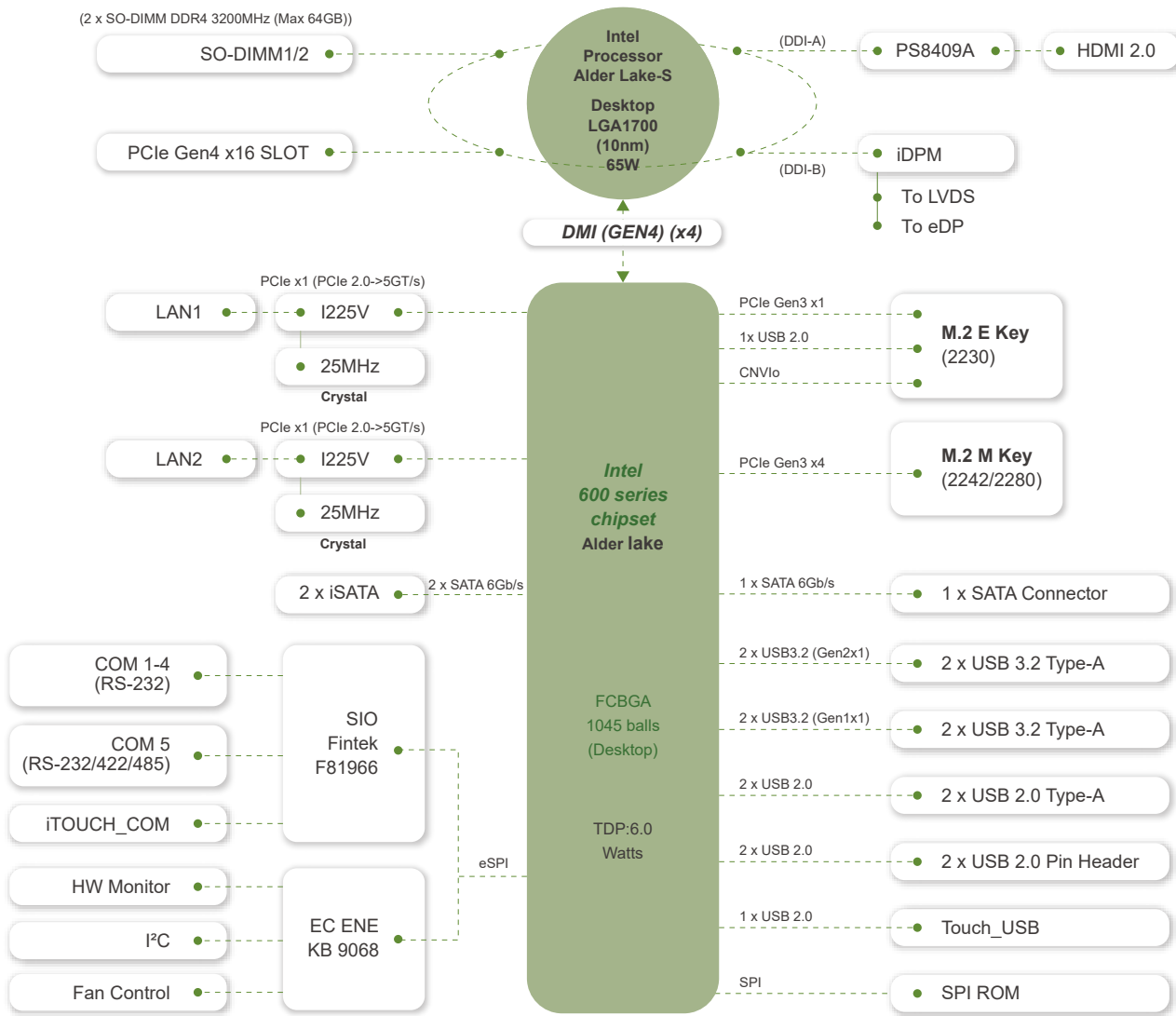

Dimensions

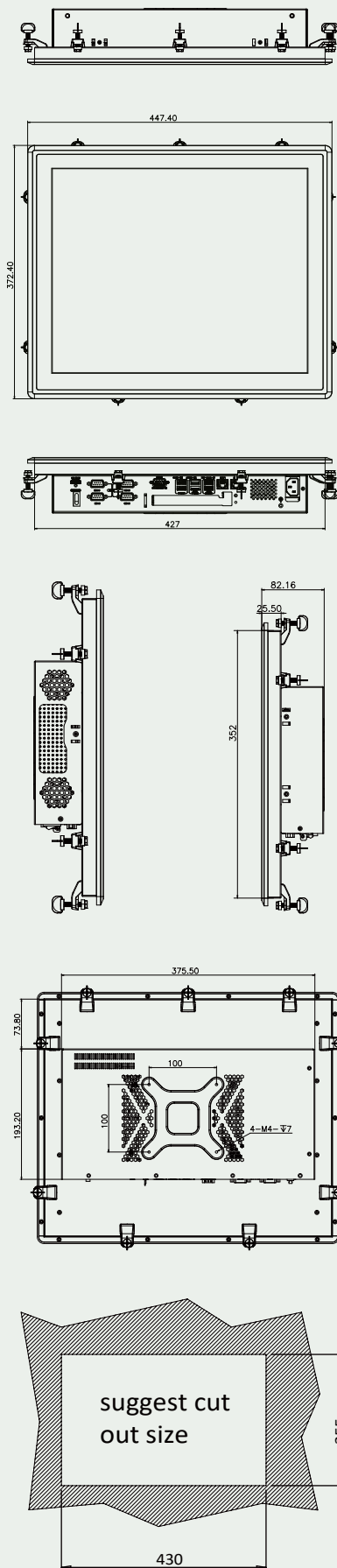

Specifications

Model	PPC2-C19-ADL	
LCD Display	19" (5:4)	
Resolution	1280 (W) x 1024 (H)	
Brightness	450 cd/m ²	
Contrast Ratio	1000:1	
LCD Color	16.7M	
Pixel Pitch (mm)	0.294 x 0.294	
Viewing Angle (H-V)	170°/160°	
Backlight MTBF	50,000 hours	
SBC Model	PPC2MB-ADL-S-R10	
CPU	12th Gen Intel® Core™ i9/i7/i5/i3 and Pentium® Processor (LGA1700)	
Chipset	Intel® H610	
Graphics Engine	New Intel® Xe Graphics architecture with SRIOV, Genlock	
Display Output	1 x HDMI 2.0	
Memory	Two 260-pin 3200 MHz dual-Channel DDR4 SO-DIMM (max. 64GB)	
Touchscreen	Multi-point projected capacitive type Surface hardness: ≥7H	
Touch Controller	Projected capacitive type: EETI 80	
Storage	1 x 2.5" SATA HDD bay	
Ethernet	LAN1: Intel® I225 + LAN2: Intel® I225 1 x PCIe Gen4 x 16 slot with x16 Signal	
Expansion	1 x M.2 E-Key 2230 (PCIe Gen3 x1 + CNVlo + USB 2.0) 1 x M.2 M Key 2242/2280 NVMe (PCIe Gen3 x 4)	
Mounting	VESA 100mm x 100mm Panel, Wall, Rack, Stand and Arm	
Construction Material	Aluminum front cover and sheet metal rear cover	
Enclosure Color	Black C	
I/O Ports, Switches and Buttons	1 x HDMI 2.0 2 x 2.5GbE RJ45 2 x USB 2.0 (Type-A) 2 x USB 3.2 Gen1 (Type-A) (5Gb/s) 2 x USB 3.2 Gen2 (Type-A) (10Gb/s) 1 x RS-232/422/485 (RS-485 support AFC)	4 x RS-232 1 x AC input 1 x Power switch 1 x Clear CMOS button 1 x Reset button 1 x AT/ATX switch
Power Supply	250W AC input ATX power supply - Input: 100V~240V AC, 47Hz-63Hz - Output (max.): 3.3V@6A, 5V@12A, 12V@17A, -12V@0.5A, +5Vsb@2A Support AT/ATX mode, ErP/EuP Compliant	
Thermal Solution	Smart fan (2 x CPU fan, 2 x System fan)	
TPM	Intel® Platform Trust Technology	
Watchdog Timer	Software Programmable Support 1~255 sec. system reset	
Operating Temperature (with air flow)	-10°C ~ 60°C	
Storage Temperature	-20°C ~ 60°C	
Humidity	10% ~ 95%@40°C, non-condensing	
IP Level	IP 65 compliant front panel	
Safety and EMC	CE, FCC Class A, UKCA	
ErP	ErP 2009/125/EC	
Dimensions(H x W x D) (mm)	447.40 x 372.40 x 82.16	
Net Weight	7.66 kg	

Packing List

1 x Power Cord	1 x QIG
1 x Panel Mount Kit	1 x Screw Pack

Ordering Information

PPC2-C19-ADL-i7/8G-R10	19" 450 cd/m ² 1280x1024 panel PC with 12th Intel® Core™ i7-12700 processor (25M cache, up to 4.90 GHz), TDP 65W, 8GB DDR4, HDMI output, 1 x PCIe Gen4 x16 slot, 1 x M.2 E key, 1 x M.2 M key, ATX/AT power supply, PCAP touchscreen with AG, R10
PPC2-C19-ADL-i5/8G-R10	19" 450 cd/m ² 1280x1024 panel PC with 12th Intel® Core™ i5-12400 processor (18M cache, up to 4.40 GHz), TDP 65W, 8GB DDR4, HDMI output, 1 x PCIe Gen4 x16 slot, 1 x M.2 E key, 1 x M.2 M key, ATX/AT power supply, PCAP touchscreen with AG, R10
PPC2-C19-ADL-i3/8G-R10	19" 450 cd/m ² 1280x1024 panel PC with 12th Intel® Core™ i3-12100 processor (12M cache, up to 4.30 GHz), TDP 60W, 8GB DDR4, HDMI output, 1 x PCIe Gen4 x16 slot, 1 x M.2 E key, 1 x M.2 M key, ATX/AT power supply, PCAP touchscreen with AG, R10
PPC2-C19-ADL-P/8G-R10	19" 450 cd/m ² 1280x1024 panel PC with 12th Intel® Pentium® Gold G7400 processor (6M cache, 3.70 GHz), TDP 46W, 8GB DDR4, HDMI output, 1 x PCIe Gen4 x16 slot, 1 x M.2 E key, 1 x M.2 M key, ATX/AT power supply, PCAP touchscreen with AG, R10

Options

Item	Part No.	Description
Arm	ARM-31-RS	VESA 75/100 desk arm
Stand	STAND-C19-R10	VESA 75/100 easy stand
Wall	AFLWK-19B	Wall mounting kit
OS	WIN10-IOTE2021-H-RS	Win10 IoT Ent LTSC 2021 MultiLang OEI High End
Wi-Fi Kit	EMB-WIFI-KIT02I3-R10	2T2R M.2 Wi-Fi module, Wi-Fi 6E & Bluetooth 5.2